

Loughborough University
Institutional Repository

*Utilisation of particle-liquid
interfacial phenomena in
augmented filtration*

This item was submitted to Loughborough University's Institutional Repository by the/an author.

Citation: WAKEMAN, R.J. and TARLETON, E.S., 1992. Utilisation of particle-liquid interfacial phenomena in augmented filtration. European Symposium on Solid-Liquid Separation, 474th event of European Federation of Chemical Engineers, Cologne, Germany, Paper L5, (6 pp.).

Additional Information:

- This is a conference paper.

Metadata Record: <https://dspace.lboro.ac.uk/2134/5717>

Version: Not specified

Please cite the published version.

This item was submitted to Loughborough's Institutional Repository (<https://dspace.lboro.ac.uk/>) by the author and is made available under the following Creative Commons Licence conditions.

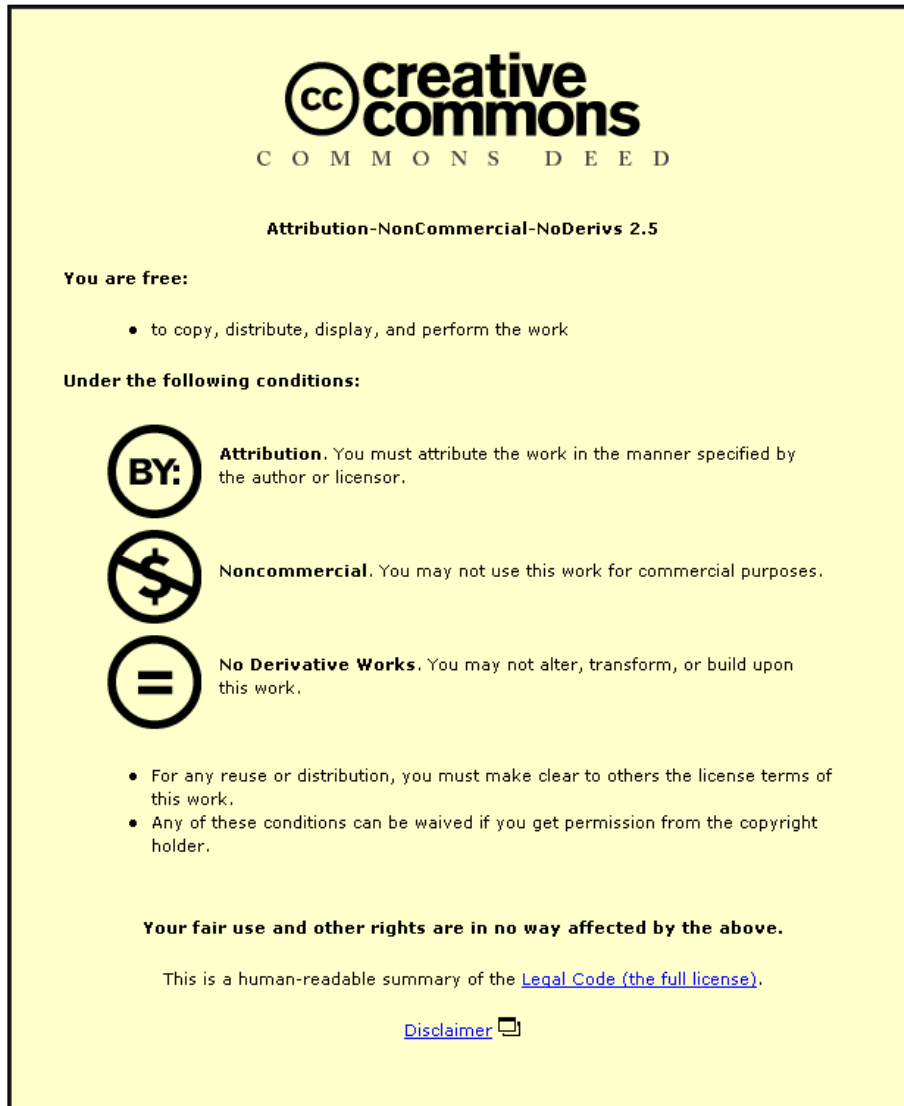

creative commons
COMMONS DEED

Attribution-NonCommercial-NoDerivs 2.5

You are free:

- to copy, distribute, display, and perform the work

Under the following conditions:

 **Attribution.** You must attribute the work in the manner specified by the author or licensor.

 **Noncommercial.** You may not use this work for commercial purposes.

 **No Derivative Works.** You may not alter, transform, or build upon this work.

- For any reuse or distribution, you must make clear to others the license terms of this work.
- Any of these conditions can be waived if you get permission from the copyright holder.

Your fair use and other rights are in no way affected by the above.

This is a human-readable summary of the [Legal Code \(the full license\)](#).

[Disclaimer](#) 

For the full text of this licence, please go to:
<http://creativecommons.org/licenses/by-nc-nd/2.5/>

UTILISATION OF PARTICLE-LIQUID INTERFACIAL PHENOMENA IN AUGMENTED FILTRATION PROCESSES

¹R.J. Wakeman and ²E.S. Tarleton (e.s.tarleton@lboro.ac.uk)

¹Separation Processes Centre, University of Exeter, Exeter, Devon, UK.

²Dept. Chemical Engineering, Loughborough University, Loughborough, Leics., UK.

ABSTRACT

Results from an experimental study of field assisted crossflow microfiltration are presented. Both electric and ultrasonic fields, either in isolation or in combination, can reduce membrane fouling by utilising particle-liquid interfacial phenomena. Synergistic effects could also be observed when the fields were applied simultaneously. Lower crossflow velocities can be utilised in microfiltration when force fields are employed which implies that pumping costs, heat transfer in recirculation loops, and the degradation of shear sensitive streams can be substantially reduced.

INTRODUCTION

Many suspensions containing a proportion of colloidal material are difficult to process by filtration due to the combined influence of fine particle size and the surface forces generated at the solid/liquid interface. Whilst membrane techniques such as crossflow ultra- and micro- filtration, where the bulk suspension flow is tangential to the filtering medium, are successfully used in many industries the phenomenon of membrane fouling remains a recurring problem that prevents their more widespread use. The accumulation of macromolecular and finer particulate material at the septum during filtration can initiate rapid flux decline and result in unacceptably low separation rates. Although mechanical techniques such as backflushing can be used to (partially) clean fouled membranes the utilisation of particle-liquid interfacial phenomena through imposed force fields to augment filtration processes, and improve separation rates, has been attracting an increasing amount of interest recently.

Augmented or field assisted separation involves the addition of an electric, sonic, ultrasonic or magnetic field to a separation process to enhance the removal of either the solid or liquid phase from the feed stream. Since the late 1960's magnetically assisted filters have been accepted as viable commercial techniques by the mining industries, however, the use of electric and in particular ultrasonic fields in solid/liquid separation has been restricted to laboratory and pilot scale studies. This paper presents results from an experimental study examining the influence of imposed electric and ultrasonic force fields on crossflow microfiltration. The technique utilises the presence of interfacial phenomenon such as particle surface charge to help prevent the formation of fouling layers at the membrane surface.

MICROFILTRATION EXPERIMENTAL PROCEDURES

The equipment used to assess the effectiveness of electric and ultrasonic fields in microfiltration is shown in Figure 1. The test rig consisted of a recirculation loop around which an aqueous (mineral) suspension of known and essentially constant composition was pumped continuously through a crossflow microfilter at constant crossflow velocity, trans-membrane pressure and temperature. The purpose built microfilter was constructed from plastics and stainless steel (as was the rest of the flow circuit and ancillaries) and comprised a supported 38 cm² membrane positioned to form one side of a rectangular flow section. The design allowed for the inclusion of mesh electrodes either side of the planar membrane and ultrasound generators in contact with the suspension on the upstream side of the membrane. Several interchangeable filter bodies enabled the distance between the ultrasound source and the membrane to be varied from 15-100 mm

whilst maintaining a fixed 3 cm gap between the electrodes used to generate the electric field. The ultrasound transducers capable of generating frequencies of 23 kHz and 40 kHz gave nominal power outputs of 3 W cm^{-2} and were mounted such that the generated ultrasound waves travelled through the feed suspension to impinge on any surface foulant or deposit which may have accumulated on the membrane. The electric field was applied through the electrodes from a constant voltage DC power supply capable of delivering up to 10 A at 400 V.

MICROFILTRATION EXPERIMENT RESULTS

The experimental programme identified the principal process and suspension characteristics which most affected the field assisted microfiltration of aqueous feed streams. Parameters such as applied field strengths, acoustic frequency, suspension concentration, liquid viscosity, particle size and particle surface charge all influenced membrane fouling to an extent dependent on their relative magnitudes¹⁻⁵. Both individual electric and ultrasonic fields reduced membrane fouling over a range of process conditions; this being principally induced by electrokinetic effects, such as electrophoresis and electroosmosis, and cavitation respectively.

Figure 2 shows the typical influence of a DC electric field on filtrate flux during the crossflow filtration of anatase suspensions. In the experiments shown no ultrasonic fields were applied and equilibrium flux increases of x4, x9, and x14 were observed on the application of electric field gradients of 25, 50 and 100 V cm^{-1} respectively, with no loss of filtrate clarity. The extent of flux improvement is dependent primarily on particle size, the magnitude of the imposed field gradient and the surface charge characteristics of the dispersed phase. The latter is closely associated with the environment near to and at the particle surfaces and can be tailored such that flux levels are significantly improved. Greater flux enhancements are possible in electrofiltration for finer particles carrying higher surface charges (higher ζ -potentials) when using steeper field gradients. Whilst it is not uncommon for flux levels to increase by an order of magnitude with the application of a suitably polarised electric field, of perhaps greater industrial significance is the ability to attain such performance at much lower crossflow velocities than those used in the operation of conventional crossflow microfilters. Investigations of this point showed that crossflow velocities of 0.1 m s^{-1} , rather than the more normal $2-8 \text{ m s}^{-1}$, could be used to advantage⁵. The potential advantages are reduced pumping costs, less heat input into the process stream, and the improved possibilities of processing shear sensitive streams, albeit at the expense of the energy input required to generate the electric field.

Figure 3 shows how an ultrasonic field, in the absence of an electric field, can reduce particulate fouling and hence flux decline in microfiltration. By increasing the intensity of the ultrasound field (expressed in this work as an ultrasonic power density gradient, $\text{W cm}^{-2} \text{ cm}^{-1}$) filtrate flux improvements up to an order of magnitude could be achieved. The gradient was varied by using an ultrasonic source with a fixed power output and changing its separation distance from the membrane surface. Whilst the flux improvements shown in Figure 3 are fairly typical of what can be achieved using power ultrasound many other factors influence the operation. Although the flux enhancements may be produced with crossflow velocities near to 0.1 m s^{-1} , higher ultrasonic frequencies, suspension concentrations, suspension viscosities and the presence of larger size particles in the feed stream often reduce the effectiveness of the applied ultrasound⁵. There is also evidence to suggest that alterations to the surface chemistry of the particles in suspension can influence the flux enhancements achievable with ultrasound³. Near to the suspension pH's corresponding to the iso-electric point and the point of maximum surface charge less flux improvement seems to occur with ultrasound, though the reasons for such behaviour are currently unclear.

Figure 4 shows the typical contributions of each field to a combined field filtration. Both electric and ultrasonic fields were seen to reduce fouling when applied individually, but the extent of improvement by the ultrasonic field could be minimal when the feed stream concentration was

higher; this is the case on Figure 4. The improvement by the electric field was usually greater than that due to the ultrasonic field, particularly when the particles were well dispersed with a high ζ -potential. When the electric and ultrasound fields were applied simultaneously a synergistic interaction occurred whereby flux levels were above those which could be expected from the simple addition of the flux improvements due to the individual fields. The synergy seemed greater with the more problematic suspensions and in particular at higher feed concentrations (tests were performed with concentrations up to 10.1% by weight).

DISCUSSION

The experimental data shown in Figures 1 to 4 illustrate the large flux increases which are achievable when electric and/or ultrasonic fields are used to aid microfiltration. However, to increase the filtration rate is not necessarily a sufficient criterion by which to assess filter performance. The energy consumed in achieving that rate can be equally as important.

Tables 1 and 2 give a break down of the power consumptions for two groups of tests (the data shown in Figure 4 corresponds with the information given in Table 1). The data indicate the contributions to the power consumed by the filter system for the pump used to provide the crossflow, the constant voltage (50 V cm^{-1}) D.C. electric field and the 23 kHz ($1.7 \text{ W cm}^{-2} \text{ cm}^{-1}$) ultrasonic field. The power input figures are quoted per unit membrane area whilst the energy consumed is expressed per unit volume of filtrate. Experiments performed with no imposed force fields employed a crossflow of 2.3 m s^{-1} (for comparison purposes) whereas all the assisted filtrations used the much lower crossflow of 0.1 m s^{-1} . While the data highlight that actual power inputs with imposed fields were in all cases higher than the corresponding tests with no fields, the energy required to produce a unit volume of filtrate could be decreased significantly for both anatase and china clay suspensions. Moreover, the time taken to extract a unit volume of filtrate from each suspension was reduced with the combined fields by x18 and x10 respectively.

Although the data in Tables 1 and 2 are encouraging they should be viewed in the light that to date little attempt has been made to minimise the power consumed by either the electric or ultrasonic fields. In the light of supplementary work carried out alongside this project it is considered that the energy consumed by the electric field could be reduced by 25 to 30%, and that consumed by the ultrasonic field by factors somewhat larger. This would reduce power input levels to between one half and two-thirds of those shown on Tables 1 and 2 whilst retaining the filtration rates shown. If this proves possible then field assisted crossflow filtration should compare favourably with conventional crossflow filtration, particularly for difficult-to-filter or 'high value' suspensions.

CONCLUSIONS

Whilst some of the observations in the experiments are difficult to interpret theoretically due to the complexity of the interactions the effects generated during assisted filtrations are often substantial. Such effects could be observed with a range of suspensions exhibiting different particle size, shape and surface properties, viscosity and feed concentration. The ability to prevent membrane fouling using imposed force fields offers the potential advantage of improved separation rates at reduced pumping costs. Preliminary comparisons of the energy requirements for conventional and field assisted microfiltrations indicate that lower overall power consumptions can be achieved with the latter. Moreover, the reduced pumping requirement has practical implications concerning the processing of shear sensitive feed streams. Such streams should undergo less degradation by the recirculation pump and require reduced cooling in batch systems.

REFERENCES

Cite paper as: Wakeman R.J. and Tarleton E.S., 1992, Utilisation of particle-liquid interfacial phenomena in augmented filtration processes, *Proc. European Symposium on Solid-Liquid Separation*, Paper L5, 6 pp., Cologne, Germany.

1. R.J. Wakeman and E.S. Tarleton, *Chem. Eng. Sci.*, **42**, 829-842, 1986.
2. E.S. Tarleton, *PhD Thesis*, University of Exeter, 1986.
3. E.S. Tarleton, *Filtration & Separation*, **25**(6), 402-406, 1988.
4. E.S. Tarleton and R.J. Wakeman, *Filtration & Separation*, **27**(3), 192-194, 1990.
5. R.J. Wakeman and E.S. Tarleton, *Chem. Eng. Res. Des.*, **69**(A5(A)), 386-397, 1991.

ACKNOWLEDGEMENTS

The authors wish to acknowledge receipt of grants from the Specially Promoted Programme in Particulate Technology of the Science and Engineering Research Council in support of this work, and of additional support from the company members of the Separation Processes Centre at Exeter University.

FIGURES AND TABLES

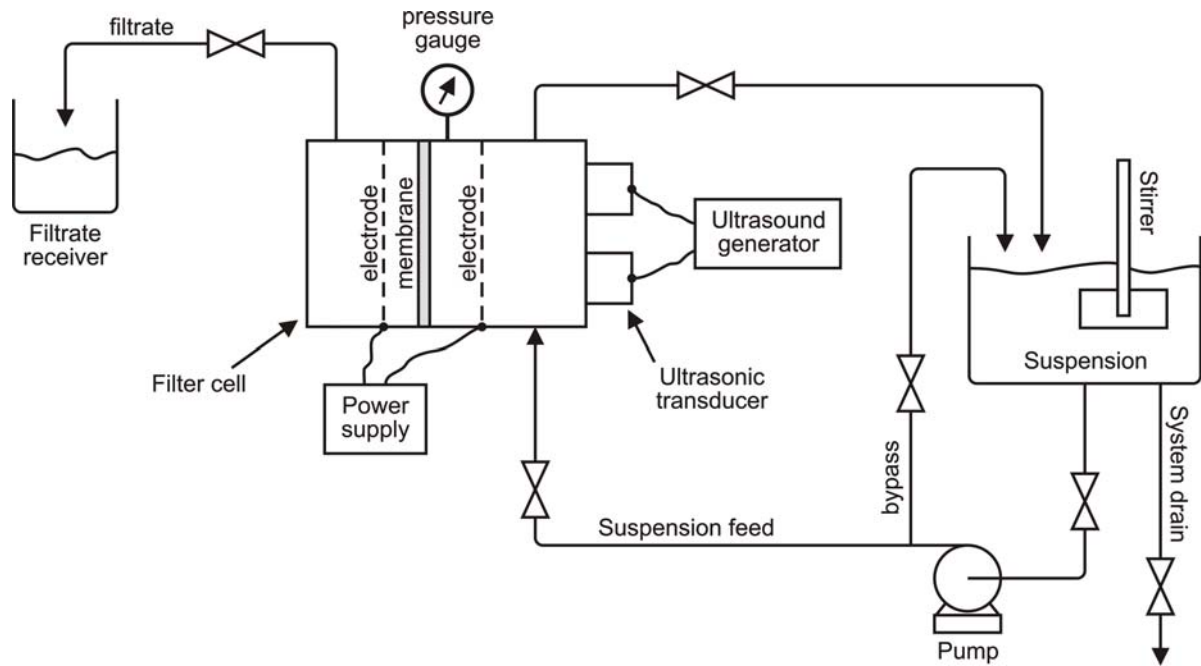

Figure 1: Schematic diagram of the microfiltration cell and flow circuit.

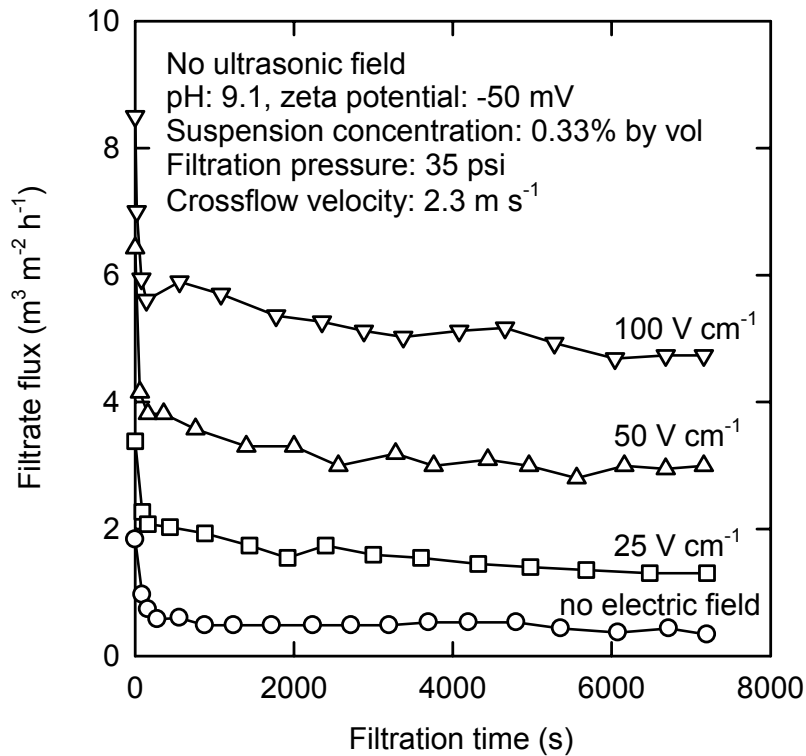

Figure 2: Typical effect of an electric field gradient on the microfiltration of anatase suspensions.

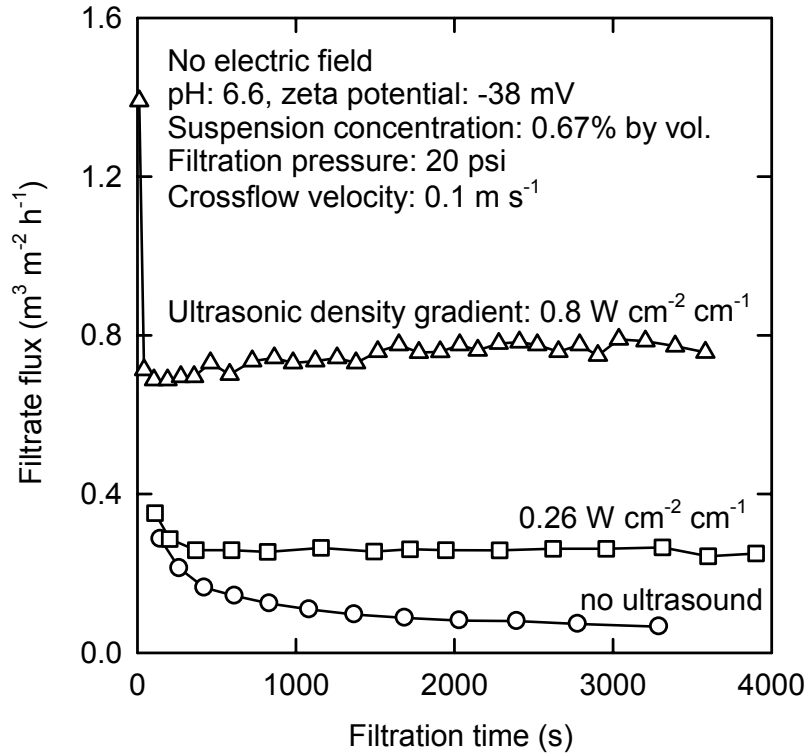

Figure 3: Effect of ultrasonic field gradient on flux decline for anatase suspensions.

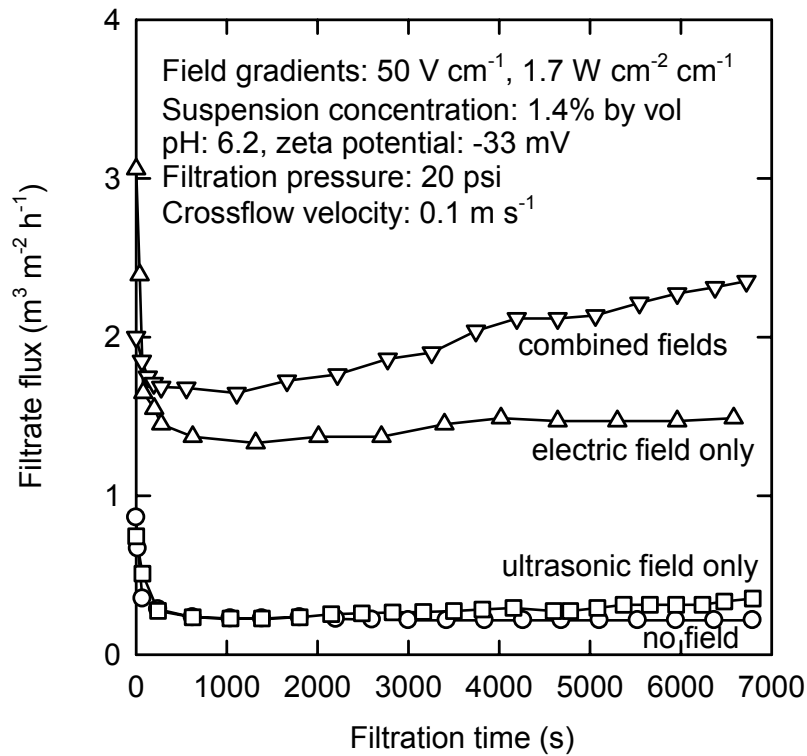

Figure 4: Synergy between electric and ultrasonic fields for china clay suspensions.

Process conditions	Power inputs to system, pump + electric + ultrasonic field (kW m ⁻²)	Energy input per unit volume of filtrate (kWh m ⁻³)
no fields	19.6 + 0 + 0 = 19.6	39.3
electric field only	0.02 + 9.1 + 0 = 9.12	6.1
ultrasonic field only	0.02 + 0 + 24.9 = 24.92	62.3
combined fields	0.02 + 13.0 + 24.9 = 37.92	16.5

Table 1: Power consumptions for the microfiltration of 1.4% v/v china clay suspensions.

Process conditions	Power inputs to system, pump + electric + ultrasonic field (kW m ⁻²)	Energy input per unit volume of filtrate (kWh m ⁻³)
no fields	19.6 + 0 + 0 = 19.6	89.1
electric field only	0.02 + 93.9 + 0 = 93.92	132.3
ultrasonic field only	0.02 + 0 + 24.9 = 24.92	113.3
combined fields	0.02 + 124.7 + 24.9 = 149.62	33.9

Table 2: Power consumptions for the microfiltration of 2.8% v/v anatase suspensions.